

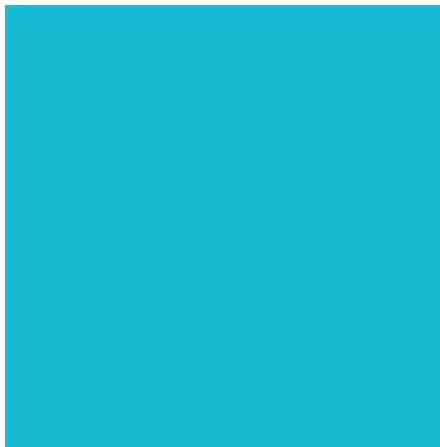

SOLUTIONS CATALOG

NEW LAB START-UP CATALOG



Start Your New Lab with Thomas Scientific, Today!



customerservice@thomassci.com



833.544.7447



thomassci.com



9001:2015





WHAT TO KNOW



Starting A Lab With Thomas Scientific:

In the dynamic world of scientific research and diagnostics, setting up a new lab can be both an exciting and daunting endeavor. Recognizing this, we are proud to introduce our New Lab Start-Up Partnership Program, designed with flexibility to support the unique needs of emerging laboratories.

Program Goals and Offerings

Our comprehensive solutions are built to facilitate a seamless start-up process, ensuring your new lab is not only equipped with essential instruments, furniture and consumables but also supported every step of the way. Keeping your goals and priorities in the forefront, we can offer any combination of the following elements:

- **Deep Product Discounts with Price Match Opportunities:** Benefit from exclusive discounts on our wide range of products, with price match options to ensure you get the best deal possible.
- **Product and Workflow Consultation and Selection:** Our experts will work with you to identify the best instruments, consumables, reagents, and equipment that align with your lab's specific research or diagnostic goals.
- **Personalized Remote Lab Design Support:** Utilizing cutting-edge augmented reality tools, we offer personalized lab design services to optimize your space for efficiency and safety.
- **Virtual/In-Person Product Demonstrations:** Get an up-close look at our products through virtual or in-person demonstrations, helping you make informed decisions about your lab equipment.
- **Regulatory and Compliance Guidance:** Navigate the complex landscape of regulatory requirements with our expert guidance, ensuring your lab complies with all necessary standards.
- **Flexible Finance Options:** We understand the financial constraints new labs often face, which is why we offer flexible financing solutions to accommodate your budget.
- **Product Installation and Training:** For selected instruments and equipment, our team will provide professional installation services, followed by comprehensive training to ensure your staff is fully equipped to use the new technology effectively.
- **Ongoing Support:** Our commitment to your success extends beyond the initial setup. With ongoing support from our technical application specialist team and partners, you can count on us for continued assistance.

TABLE OF CONTENTS

WHO IS ELIGIBLE.....	4-5
NEW LAB START-UP OFFERS.....	6
CHECKLISTS (E&I).....	7-9
Equipment.....	8
Instruments.....	9
CUSTOM LAB PROJECTS.....	10
FURNITURE.....	11-14
Your Furniture Source.....	11
Quick Ship Furniture Program.....	12
Furniture Configurators.....	13
Furniture Checklist.....	14
WORKFLOW CONSULTATIONS.....	15-16
CHECKLISTS & SERVICES.....	17
Glassware & Plasticware.....	18
Supplies.....	19-20
Chemicals.....	21
Safety.....	22
NOTES.....	23



With over a million products, which include all of the major brands plus our own product portfolio, we are sure to find exactly what you need! Visit **Thomassci.com** or speak with your local Thomas Scientific Sales Representative for all of your options!



FIND OUT IF THE THOMAS SCIENTIFIC
NEW LAB START-UP PROGRAM IS RIGHT
FOR YOU.

SPECIAL OFFERS

WHO IS ELIGIBLE

THOMAS SCIENTIFIC CAN PROVIDE COMPLETE SOLUTIONS FOR:



Starting a New Lab
Within Your Company/
Institution



Expanding or Refurbishing
Your Existing Lab



Starting a New Company



Moving Your Lab into a
New Space

GETTING STARTED IS EASY:

- 1** Look through our product checklists starting on page 8 and mark what you might need or utilize your own.
- 2** Connect with your Thomas Scientific sales representative to discuss the next steps or simply request a quote.
- 3** Get back to the science, we will take care of the rest.

Don't have a Thomas Scientific Rep, yet? This is quickly solved by calling us at 833.544.SHIP (7447) or chatting with us online at [ThomasSci.com](https://www.thomassci.com)

Your Rep's Contact Info:

Name: _____

Cell: _____

Email: _____

NEW LAB START-UP OFFERS

Thomas Scientific's [Deals](#) page features Thomas Bundles, as well as Branded, promotions, samples, and other savings programs.

We are constantly adding new offers, so be sure to check our page often. Below are some deals that are available for all of 2024:



Thomas Scientific
Serological Pipet Buy 3. Get 1 Free Promo!

Buy 3 Cases of Select labForce Serological Pipets, Get 1 Case FREE*!
Promotion expires June 30, 2025



Benchmark
Centrifuge Bundles

Save on your favorite centrifuges from Benchmark Scientific
Promotion expires June 30, 2025

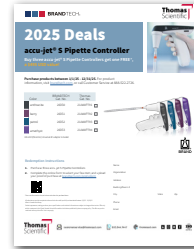

BrandTech
FREE accu-jet®S Pipette Controller

Purchase three accu-jet®S Pipette Controllers, Get one FREE - a \$495 USD value!
Promotion expires Dec. 31, 2025



BrandTech
FREE BRANDTECH Products!

Get \$500 in BRANDTECH products (list price) when you purchase a VACUUBRAND® pump or system.
Promotion expires Dec. 31, 2025



BrandTech
FREE HandyStep S Mechanical Repeating Pipette

Get a FREE HandyStep S Mechanical Repeating Pipette when you purchase 5 boxes of PD-Tip™ II Precision Dispenser Tips, up to a \$357 USD value!
Promotion expires Dec. 31, 2025



Corning
Complimentary New Lab Startup Kit

A complimentary box of lab supplies including packs of Corning® plasticware and media, as well as Falcon®, PYREX®, and Axygen® samples.

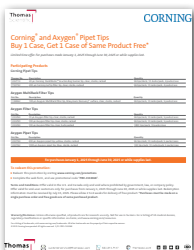

Corning
Corning® and Axygen® Pipet Tips

Buy 1 Case, Get 1 Case of Same Product Free
Promotion expires June 30, 2025

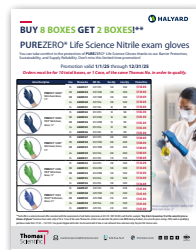

Halyard
PUREZERO* Life Science Nitrile Exam Gloves

Buy 8 Boxes, get 2 Boxes Free!
Promotion expires Dec. 31, 2025



MP Bio
7X Detergents

Buy 3, Get 1 Free on 7X Detergents – More Clean, More Savings!
Promotion expires June 30, 2025

For all of our latest Deals and Offers, visit [ThomasSci.com](https://www.thomasci.com) and click on Deals on the main menu bar!

Looking for the best deal?
Our exclusive Thomas Brand solutions are highlighted with bold lettering on the product checklists offering savings as high as 60%!

EQUIPMENT

INSTRUMENTS

FURNITURE

CHECKLISTS & SERVICES

EQUIPMENT

ANAEROBIC SYSTEMS

- Chambers
- Indicators
- Jars

ANESTHESIA EQUIPMENT

AUTOCLAVES/STERILIZERS

- Portable
- Top-Loading

BLENDERS

CELL COUNTERS

CENTRIFUGES

- Benchtop**
- Centrifugal Concentrators**
- Clinical
- Floor/Ultra
- Micro/Mini**
- Refrigerated
- Rotors and Adapters

CIRCULATORS/CHILLERS

- Benchtop
- Floor
- Heated and Refrigerated
- Immersion
- Refrigerated

CRYOGENIC STORAGE

- Auto-Fill Systems
- Dewar Flasks
- Laptop Coolers
- Storage Tanks

DISINFECTING SYSTEMS

DRY BLOCK HEATERS

ELECTROPHORESIS SYSTEMS

ELECTROPORATION

- Cuvettes**
- Equipment

ENVIRONMENTAL TEST CHAMBERS

EXTRACTION SYSTEMS

FILLING SYSTEMS

FREEZE DRY SYSTEMS

FUMING CHAMBERS

FURNACES

GLASSWARE WASHERS

- Large Capacity
- Mobile
- Undercounter

HOMOGENIZERS

- Bead Mill
- Handheld

HOT PLATES AND STIRRERS

- Hot Plate Stirrers**
- Magnetic
- MagnetiHot Plate
- Overhead
- Stir Bars

ICE MAKERS

- Ice Buckets

IMAGING SYSTEMS

INCUBATORS

- BOD/Refrigerated
- CO₂
- General Purpose**
- Hybridization
- Shaking**
- Water-Jacketed

MICROSTERILIZERS

MILLS

- Cutting**
- Grinding**
- Planetary Ball

OVENS

- Cleanroom
- Forced Air
- General Purpose
- Gravity Convection
- Hybridization
- Safety
- Vacuum

PLATERS

POWER SUPPLIES

PRESSES

- Heat
- Pellet
- Rosin

PUMPS

- Peristaltic
- Syringeless
- Tubing
- Vacuum

REFRIGERATORS/FREEZERS

- Blood Bank
- Chest
- Chromatography
- Compact
- Explosion-Proof
- Flammable Storage
- General Purpose
- Laboratory Pharmacy
- Ultra-Low Temperature
- Undercounter

ROLLERS

ROTARY EVAPORATORS

- Replacement Glassware

ROTATORS

SHAKERS

- Benchtop**
- Incubating
- Microtiter
- Mini**
- Nutating
- Orbital**
- Rocking**
- Rotating**
- Sieve

SOLVENT RECYCLING SYSTEMS

STIR BARS

- Retriever
- Stirring Bar Garage

THERMAL CYCLERS

- qPCR**

TISSUE GRINDERS

TRANSILLUMINATORS

ULTRASONIC CELL DISRUPTORS

ULTRASONIC CLEANERS

VACUUM CLEANERS

VORTEXERS/MIXERS

- Multi-Tube**
- Nutating

WATER BATHS

- Circulating
- General Purpose
- Shaking

WATER PURIFICATION SYSTEMS

- De-Ionizer Cartridges

INSTRUMENTS

○ AUTOMATED NUCLEIC ACID PURIFICATION SYSTEMS

BALANCES

- **Analytical**
- Ergoclips
- Industrial
- **Micro**
- Moisture Analyzers
- Spatulas/**Scoops**
- **Top-Loading**
- **Weigh Dishes**

○ BAROMETERS

○ CALCULATORS

○ CALIPERS

○ CLOCKS

○ COLORIMETERS

○ CONDUCTIVITY

DATA LOGGERS

- Central Monitoring Systems
- Portable
- Temperature

○ DIGITAL BURETTES

ELECTROCHEMISTRY

- **Buffers**
- **Conductivity Meters**
- DO Meters
- Electrode Stands
- **Electrodes**
- ISE Meters
- Multiparameter Meter/Printers
- **pH Meters**
- Printers
- Stirrers
- Storage Solutions

○ FLASH POINT TESTERS

○ FLUOROMETERS

○ GEL DOCUMENTATION IMAGING SYSTEMS

○ HYDROMETERS

○ HYGROMETERS

○ LUMINOMETERS

○ MELTING POINT APPARATUS

○ MICROPLATE READERS

○ MICROPLATE WASHERS

MICROSCOPES

- Adhesives
- Cameras
- Compound Microscopes
- Cover Slips
- Digital Microscopes
- Dust Covers
- Inverted Microscopes
- Light Sources
- Metallurgical Microscopes
- Objectives
- **Slides**
- Stage Holders
- Stains/Dyes
- Stereo Microscopes

○ MOISTURE ANALYZERS

○ PH METERS

PLATES

- Reagents

○ RECORDERS

REFRACTOMETERS

- Bench
- Handheld

SPECTROPHOTOMETERS

- **Cuvettes**
- Double Beam
- Single Beam
- Split-Beam
- UV/VIS

○ STOPWATCHES

○ TIMERS

TITRATION

- Autosampler Titrators
- Electrodes
- Karl Fischer Titrators
- Reagents

○ VISCOMETERS



CUSTOM LABORATORY PROJECT IDEAS

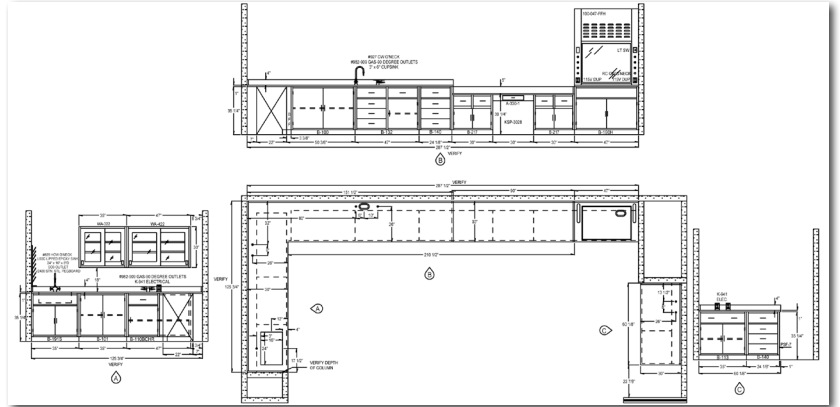

Let's build something together! We are here to listen and collaborate on a lab designed to maximize workflow efficiency and productivity for projects of all sizes. Thomas Scientifics' unique team of experts and extended partners can upgrade, renovate or build a brand-new lab made to last!

Custom projects are built for your needs and may include consultation, design, delivery and installation. Our extended support team includes:

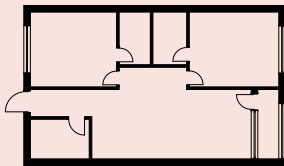

Furniture Specialists

Furniture specialists design the most efficient and budget-friendly layout for your laboratory.



Project Estimators

Project estimators deliver a detailed assessment of your requirements and the associated costs for the project.

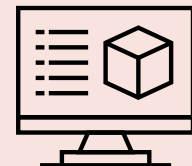

Design Specialists

Design specialists produce AutoCAD plans and elevation drawings that optimize the use of space while adhering to established safety standards.



Project Managers

Project managers supervise every aspect of your project from beginning to end.

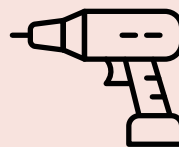

Factory Trained Installers

Factory-trained installers ensure a seamless and hassle-free completion of your project.

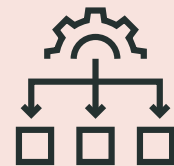

Workflow Specialists

We specialize in providing innovative solutions for any application.

YOUR FURNITURE SOURCE

We bring you the best brands in the industry



For full details and furniture portfolio, check out: [ThomasSci.com/Furniture](https://www.thomasci.com/Furniture) for details!



Biosafety Cabinets • Benches • Carts • Cabinets • Countertops • Emergency Eyewash Stations & Showers Fixtures • Glassware Washers • Fume Hoods & Enclosures • Laboratory Seating
Racks & Bins • Safety Storage Cabinets • Shelving • Tables

For all of our Furniture programs, visit: [ThomasSci.com](https://www.thomasci.com) and click on Furniture under our Laboratory section!

THOMAS QUICK SHIP FURNITURE PROGRAM

Lab Furnishings

Science moves fast, and you can trust Thomas Scientific to sprint at your pace with our Quick Ship Program. We offer an extensive selection of lab furnishings that are available in a matter of days and complete laboratories can ship within 10 days!

- Cabinets
- Carts
- Chairs & Stools
- Countertops
- Fume Hoods
- Shelving
- Sinks & Faucets
- Tables
- Workstations

With over 600 quick ship solutions, we will find the furniture for your timeline.



Quick Ship Flip Book

For all of our Furniture programs, visit: ThomasSci.com and click on Furniture under our Laboratory section!

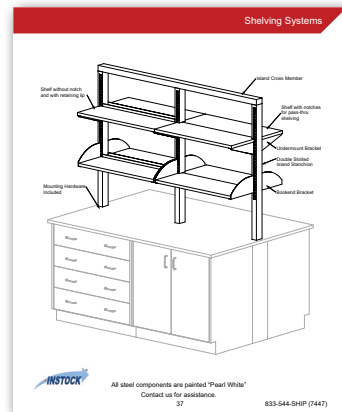
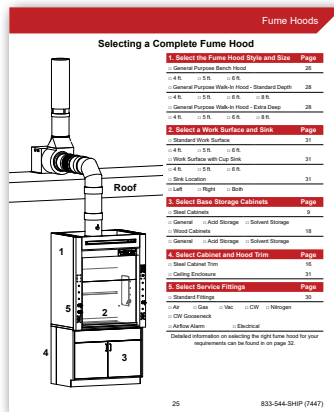

THOMAS FURNITURE CONFIGURATORS

Thomas Chairs: [Build Your Thomas Chair Online Now!](#)

Our laboratory chairs feature the latest advancements in laboratory ergonomics, such as contoured waterfall cushions and 6-way armrests, for improved posture and blood circulation. Styles: Chairs, Stools, & Stools with Backs.

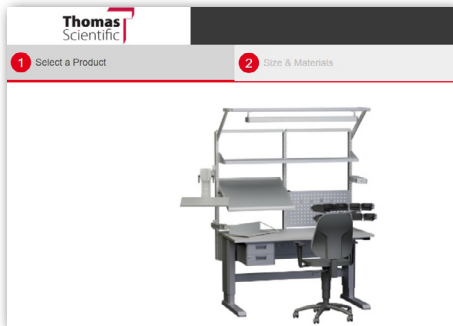
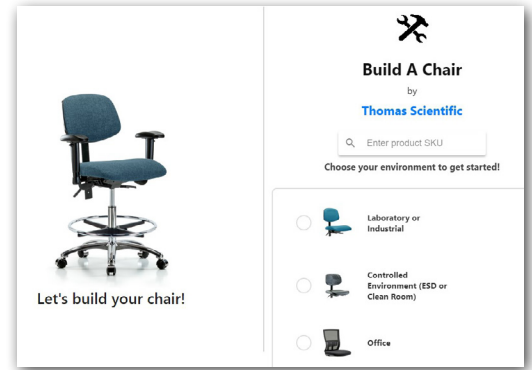

Treston Online [Workstation Configurator](#)

The Treston 3D Design tool allows you to design and build your own customized workstation from frame to accessories. You can see the workstation take form on your screen, and are able to submit it directly to us for a quote upon completion.

 <p>Concept Workbench</p> <p>Versatile bench with widest range of accessories. Easy to customize. Electric, crank and standard frames.</p> <ul style="list-style-type: none"> • Available with ESD protection • Suitable for regular use with weights up to 1100 Lbs. <p>Configure Now</p>	 <p>Cornerstone</p> <p>Heavy-duty bench suitable for a wide range of applications.</p> <ul style="list-style-type: none"> • Available with ESD protection • Suitable for regular use with weights up to 2000 Lbs. <p>Configure Now</p>	 <p>TP Workbench</p> <p>A cost-effective basic bench with excellent range of accessories. For wide range of tasks.</p> <ul style="list-style-type: none"> • Available with ESD protection • Suitable for regular use with weights up to 661 Lbs. <p>Configure Now</p>
--	--	---

Thomas Scientific Furniture is a commitment to Customer Satisfaction. From Start to Finish, we offer complete Customer Support.

For all of our Furniture programs, visit: [ThomasSci.com](#) and click on Furniture under our Laboratory section!

FURNITURE

BALANCE TABLE

BIOSAFETY CABINET

CARTS

- Laundry
- Metal
- Metal-Wire
- Plastic
- Platform
- Security Cages

CASEWORK

- Plastic Laminate
- Polypropylene
- Stainless Steel
- Steel
- Wood

CEILING PANELS/OVERHEAD

SERVICE CARRIERS

CENTRALIZED WATER SYSTEMS

COUNTERTOPS

- Butcher Block
- Epoxy
- Phenolic
- Plastic Laminate
- Stainless Steel

DISPENSERS

DOLLIES

DRYING RACKS/PEG BOARDS

- Epoxy
- Phenolic

ENVIRONMENTAL WALK-IN

MINI ROOMS

EYEWASHES/EYEWASH STATIONS

FAUCETS

FITTINGS

FIXTURES

FUME EXTRACTORS

FUME HOODS

- Ducted
- Ductless

GLOVE BOXES

GOWNING RACKS & BENCHES

LADDERS

LOCKERS

- Plastic Laminate
- Steel

MODULAR WORKSTATIONS

MONITOR ARMS/CPU HOLDERS

PREFABRICATED CLEANROOMS

SEATING

- Chairs
- Stools

SEISMIC FASTENING SYSTEMS

SHELVING

- Metal-Wire
- Phenolic
- Plastic Laminate
- Steel

SINKS

- Epoxy
- Plastic
- Stainless Steel

STEAM STERILIZATION/
AUTOCLAVES

STORAGE CABINETS

- Plastic Laminate
- Polypropylene
- Stainless Steel
- Steel
- Wood

TABLES

- Stainless Steel
- Steel
- Wood

TASK LIGHTING

VENTILATED ENCLOSURES

WORKBENCHES





— WORKFLOW CONSULTATIONS

WORKFLOW CONSULTATION

Complimentary Workflow Evaluation from Thomas Scientific

Ready to get scientific? After reviewing your checklist needs with your Thomas Sales Representative, schedule a FREE consultation with our in-house PhD'd scientific workflow specialists. Speak in the specific scientific language around the following workflows and more:

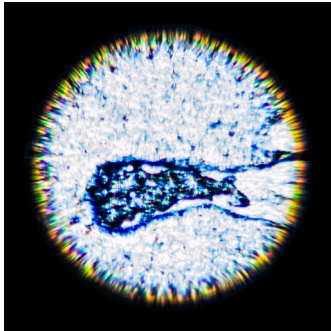

Cellular imaging and analysis

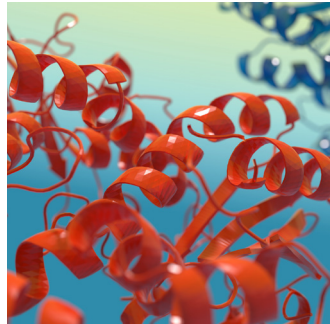

Cloning and protein expression

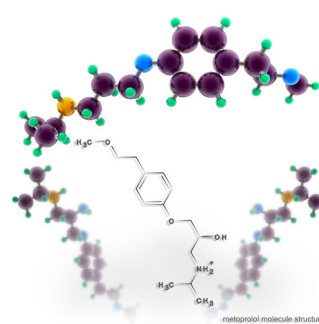

Nucleic acid isolation

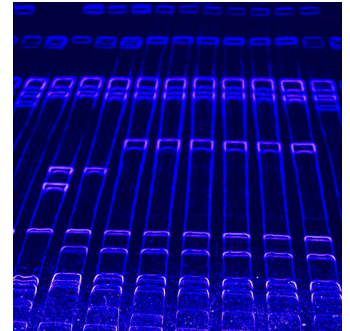

PCR and electrophoresis

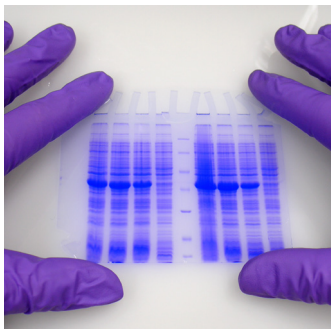

Protein analysis



Protein isolation and purification

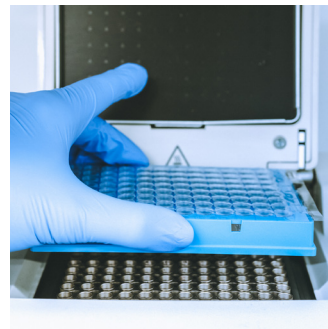

Real-time PCR and sequencing

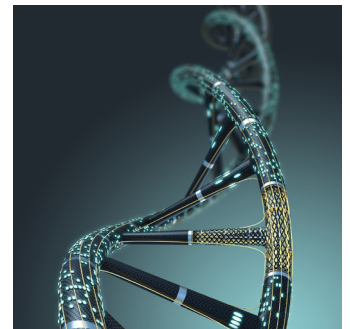

Synthetic biology, genetic engineering and services

Need Some Help?

Our experts are standing by, to offer you a free custom workflow consultation. Visit our [Diagnostics](#) page to get started today! Our team will get back in touch with you soon to help create a custom solution for your high-complexity diagnostic testing lab. We look forward to working with you and being your partner.

Last Name *

Email *

Business Phone *

Company *

Zip Code *

What does your lab need help with right now?
Please select all that apply.

<input type="checkbox"/> Automation	<input type="checkbox"/> Workflow efficiency
<input type="checkbox"/> Sample collection	<input type="checkbox"/> Nucleic Acid Extraction
<input type="checkbox"/> Pathogen Detection	<input type="checkbox"/> Sample Storage
<input type="checkbox"/> PCR	<input type="checkbox"/> NGS
<input type="checkbox"/> CRISPR	<input type="checkbox"/> Other

For more information, visit: [ThomasSci.com](#) and Click on *Diagnostics* on the menu bar!

GLASSWARE & PLASTICWARE

SUPPLIES

CHEMICALS

SAFETY

CHECKLISTS & SERVICES

GLASSWARE & PLASTICWARE

BEAKERS

- Low-Form, Heavy-Duty
- Low-Form, Standard**

BOTTLES

- Aspirator
- BOD
- Caps/Closures**
- Centrifuge
- Dropping
- Reagent/Media**
- Roller**
- Sampling**
- Storage**
- Wash**

BURETS

CARBOYS

CUVETTES

- Glass
- Plastic**

CYLINDERS, GRADUATED

- Glass**
- Plastic**

DESICCATORS

DISHES

- Cell Culture
- Crystallizing
- Evaporating
- Petri**
- Staining
- Weighing**

FLASKS

- Boiling
- Cell/Tissue Culture**
- Distillation
- Erlenmeyer**
- Fernbach
- Filtering**
- Nephelo
- Trypsinizing
- Volumetric**

FUNNELS

- Buchner
- Dropping
- Filter**
- Powder**
- Separating

HYDROMETERS

PIPETTING

- Mohr Pipets
- Pasteur Pipets
- Pipette Tips**
- Serological Pipets**
- Transfer Pipets**
- Volumetric Pipets**

PLATES

- Assay
- Crystallography
- Filter Plates
- High-Throughput Screening**
- Microliter
- Microtiter
- Multiwell
- Optical
- PCR**
- Sealing Mats and Films**
- Spot

SPECIALTY GLASSWARE

- Apparatus Sets
- Glassware Connectors
- Safety-Coated

STORAGE BOXES & RACKS

- Cryogenic
- Pipette Tips
- Tubes
- Vials

TISSUE CULTURE

- 3D and Confocal Dishes
- Cell Chambers
- Cell Slides
- Cell Spreaders, Scrapers and
- Lifters
- Cloning Cylinders
- Filling Bells
- Flasks**
- Gas Dispersion Tubes
- Plates**
- Roller Bottles
- Serological Pipets**
- Solution Bottles

TUBES

- Absorption
- Blood & Urine Collection
- Centrifuge**
- Conical
- Culture (Disposable and Reusable)
- Drying
- Gas Dispersion
- Microcentrifuge**
- Microtubes**
- PCR**
- Racks
- Sample
- Test Tubes
- Thistle

VIALS

- Cryogenic
- Racks & Storage
- Sampling
- Scintillation
- VOA/TOC



○ ALUMINUM FOIL

○ AUTOCLAVE TAPE

BAGS

- Autoclavable
- Biohazard
- Resealable
- Sample
- Specimen
- Sterile
- Stomacher
- Trash

○ BENCH PROTECTORS

BIO-PROCESS, SINGLE-USE

- 2D & 3D Bags
- Bioreactors
- Made-to-Order Kits
- Multi-Process Custom Products

○ BOTTLE-TOP DISPENSERS

○ BRUSHES

○ BULBS

○ BUNSEN BURNERS

CLAMPS/SUPPORTS

- Bossheads
- Extension Clamps
- Laboratory Jacks
- Ring Stands
- Test Tube Clamps
- Tripod Stands
- Utility Clamps

○ CLEANERS/DISINFECTANTS

○ CRUCIBLES

CRYOGENIC FREEZING

- Boxes/Racks
- Cell Dividers
- Cryogenic Vials
- Labels
- Monitors
- Shipping Containers

○ DISSECTING TOOLS

FILTRATION

- Bottle Top
- Capsules
- Centrifugal
- Concentrators
- Dialysis Tubing
- Filter Holders
- Funnels (Filter & Buchner)
- Glass Fiber
- Membrane
- Microfiber
- Paper (qualitative/quantitative)
- Plates
- Syringe
- Thimbles
- Vacuum Systems

HANDCARE

- Alcohol Scrubs
- Hand Soaps
- Lotions

LABELS AND TAPES

- Autoclave
- Biohazard
- Chemical Resistant
- Cleanroom
- Cryogenic
- Dispensers
- Hazcom
- Indicator
- Markers/Pens
- Sealing
- Tamper-Evident

LIQUID HANDLING

- Pipet Controllers

○ LOOPS/NEEDLES

MICROSCOPE SUPPLIES

- Coverslips
- Dispensers
- Histology Cassettes
- Microtomes
- Mounting Media
- Parafin
- Precleaned Slides
- Staining Jars & Trays
- Stains
- Storage Boxes

○ MORTARS AND PESTLES

NOTEBOOKS

- Cleanroom
- General Use
- Pens

RACKS

- Baskets
- Centrifuge Tube
- Glassware
- Microcentrifuge Tube
- Petri Dish
- Pipette Rack
- Test Tube

RESERVOIRS

- Automation
- Multi-Well
- Single-Well

STIR BARS

- Retriever
- Stirring Bar Garage



SUPPLIES

STORAGE/TRANSPORT

- Cold Packs
- Coolers
- Pallet Covers
- Mailers
- Shippers
- Storage Boxes
- Wraps
- Zero Waste Boxes

○ SWABS

THERMOMETERS

- Dial
- Digital
- Immersion
- Infrared
- Thermistor Probe

TIMERS

- Alarms
- Clocks
- Digital
- Memory
- Stopwatches

○ TRAYS

TUBING

- Capillary
- Connectors
- Dialysis
- Glass
- Rubber
- Silicone

UTENSILS

- Scoops
- Spatulas
- Spoons
- Stir Rods
- Tongs

WEIGHING SUPPLIES

- Boats
- Dishes
- Paper
- Scoops
- Spoons

WIPES

- Alcohol
- General Use



ACIDS, ACS GRADE

- Acetic Acid
- Hydrochloric
- Hydrofluoric
- Formic
- Nitric
- Perchloric
- Phosphoric
- Sulfuric
- Trifluoroacetic (TFA)**

ACIDS, HIGH PURITY

- Acetic
- Hydrochloric
- Hydrofluoric
- Nitric
- Phosphoric
- Sulfuric

BUFFERS, REFERENCE

- Clear pH 1-12.45**
- Color-Coded pH 4, 7, 10**
- Ion Strength Adjustment (ISAB)
- Phosphate, for BOD
- Total IoniStrength (TISAB)
- Water Hardness Buffer

MOBILE ANALYTICS

- Ion-Specific Tests
- pH Test Strips
- Refractometry
- Sanitizer Test Kits
- Total Hardness

SALTS, BASES ACS GRADE

- Ammonium Nitrate
- Calcium Carbonate
- Potassium Chloride
- Potassium Iodide
- Potassium Nitrate
- Silver Nitrate
- Sodium Chloride
- Sodium Hydroxide

SOLUTIONS, NORMAL, MOLAR AND PERCENT

- Calcium Chloride 2.75%**
- ETDA 0.0005 - 0.1M**
- Ferric Chloride 0.025%**
- Formalin
- Hydrochloric Acid 0.02 – 7.7N**
- KI 0.0079 – 1.0N and 50%**
- KOH in MeOH 0,5N**
- Potassium Hydroxide
- Potassium Iodide
- Silver Nitrate 0.014 – 0.171N**
- Sodium Hydroxide 0.01 – 10.0N**
- Sodium Thiosulfate 0.00387 – 1.0N**
- Sulfuric Acid 0.02 – 6.0N**

SOLVENTS, ACS GRADE

- Acetone
- Chloroform
- Ethanol
- Ethyl Ether
- Isopropanol (IPA)
- Methanol

SOLVENTS, HIGH PURITY

- Acetonitrile
- Dichloromethane (DCM)
- Hexane
- Methanol
- Tetrahydrofuran (THF)
- Water

SOLVENTS, LABORATORY, ACS, REAGENT, HPLC, LC-MS, TRACE, HRGC GRADES

- Acetonitrile
- Dichloromethane (DCM)
- Dimethylformamide (DMF)
- Ethyl Acetate
- Heptane
- Hexane
- Isopropanol (IPA)**
- Methanol
- n-Pentane
- Tetrahydrofuran (THF)
- Toluene
- Xylene

STANDARDS, ORGANIC AND INORGANIC

- Cannabis
- Conductivity**
- Drug
- Fluoride (EPA/APHA)
- Ion Chromatography
- Multi-Element Sets, for AA/ICP
- Pesticide (EPA Methods)
- Single Element, for AA/ICP
- Total Organic Carbon (TOC)
- Toxicology



SAFETY

ADHESIVES, SEALANTS AND TAPE

AUTOMATED EXTERNAL DEFIBRILLATORS (AEDS)

APPAREL

- Aprons
- Caps
- Chemical-Resistant
- Coveralls
- Cuff Tape
- Frocks & Gowns
- Lab Coats
- Hoods & Face Covers
- Masks, Surgical
- Sleeves and Oversleeves
- Scrubs
- Shoe and Boot Covers
- Smocks

BIOHAZARDOUS WASTE CONTAINERS

BOTTLE CARRIERS

CHEMICAL STORAGE

CLEANROOM SUPPLIES

EAR PROTECTION

EMERGENCY RESPONSE

ENVIRONMENTAL MONITORING AND GAS DETECTION PRODUCTS

ERGONOMIC FLOOR MATS AND SHOE INSERTS

EYE PROTECTION

- Glasses
- Goggles

EYE WASH KITS/STATIONS

FACE MASKS

FACE AND HEAD PROTECTION

FIRST AID

GLOVES

- Chemical-Resistant
- Cut-Resistant
- Laboratory Exam
- Liners
- Special Application
- Temperature-Resistant

GLOVE BOXES/DISPENSERS

HYGIENE (HAND)

- Alcohol Scrub
- Hand Soap
- Lotion

RADIATION PROTECTION

RESPIRATORS

- Disposable
- Powered-Air
- Reusable

SAFETY CABINETS

SAFETY CANS

SAFETY SIGNS

SHARPS CONTAINERS

SORBENTS/SPILL KITS/MATS



NOTES:

CHECK OUT OUR LINE OF THOMAS BRAND CATALOGS:

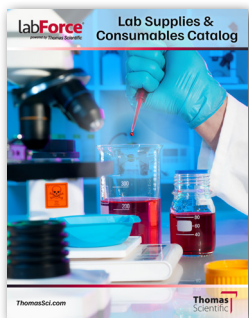

[labForce® Supplies & Consumables](#)



[labForce® Equipment & Instrumentation](#)

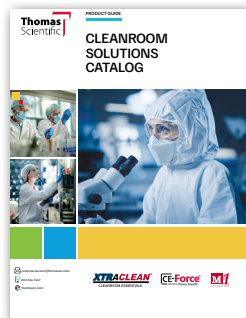

[Cleanroom Solutions](#)



[Wiley® Mill](#)

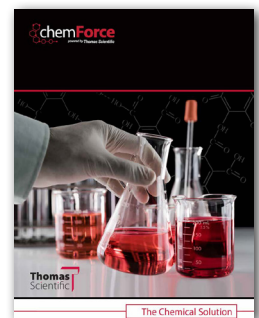

[chemForce®](#)

For more great literature, visit [ThomasSci.com](#), click on Deals on the main menu bar, then select the Resources Tab!

CONNECT WITH US.

 service@thomassci.com

 833.544.7447

 thomassci.com

